

Article number: 201226040

Description: E+G Magnets with bore GN 50.4-HF-50-10-8,5
Hard ferrite - 200° C, 180N

Measures

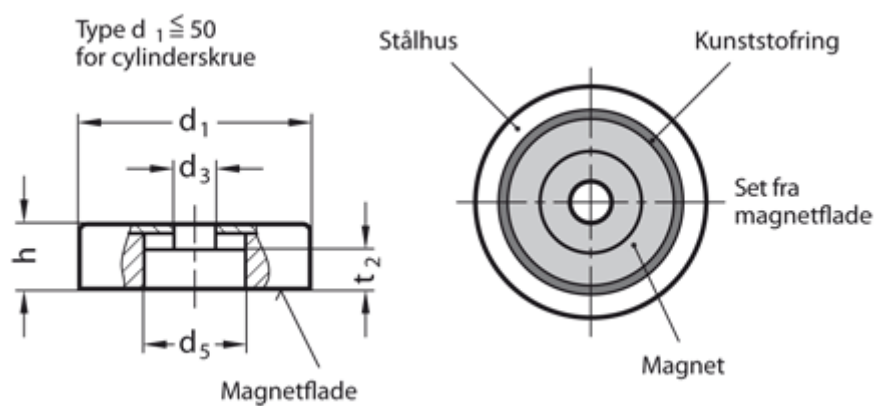

d1 = 50 +0,2/-0,1

d3 = 8.5

d5 = 22.0

h = 10 +0,5/-0,1

Holding force N = 180

Material = HF hard ferrite - 200°.C

t2 = 8.5